

Installation instructions

i Refer to installation use and maintenance manual for more information.
Available user manual at link <http://www.everelettronica.it/manhw.html>



2 phase step motor bipolar chopper drive technical data

- DC power supply : $24 \pm 80Vdc$ (suggested 68 Vdc);
- Phase current : $1.0 \pm 5.5 ARMS$ ($1.4 \pm 7.8 APK$);
- Chopper frequency: 33KHz Ultrasonic ;
- Step angle: Full Step, $\frac{1}{2}$, $\frac{1}{4}$, $\frac{1}{8}$, $\frac{1}{16}$, $\frac{1}{32}$, $\frac{1}{64}$, $\frac{1}{128}$, $\frac{1}{256}$, $\frac{1}{5}$, $\frac{1}{10}$, $\frac{1}{25}$, $\frac{1}{50}$, $\frac{1}{125}$, $\frac{1}{250}$ configurable by means of DIP-Switches;
- Current reduction: automatically at standstill motor, enabled through DIP-Switch;
- Protections against : over current, over/under voltage, overheating, short circuit between motor phase-to-phase and phase-to-ground;
- Digital inputs (optically isolated) : EN (Enable), STEP (Step or CLK_UP), DIR (Direction or CLK_DWN);
- Digital output (optically isolated) : FAULT;
- Visualizations : green Led POWER ON, green Led READY;
- Dimensions and weight : $120 \times 97,5 \times 45,5$ mm. The connectors excluded (L x D x H : refer to figure); weight : 500 gr ;
- Protection degree : IP20 ;
- Working temperature $5^{\circ}C \pm 40^{\circ}C$; Storage temperature $-25^{\circ}C \pm 55^{\circ}C$;
- Humidity : $5\% \pm 85\%$;

Mechanical data

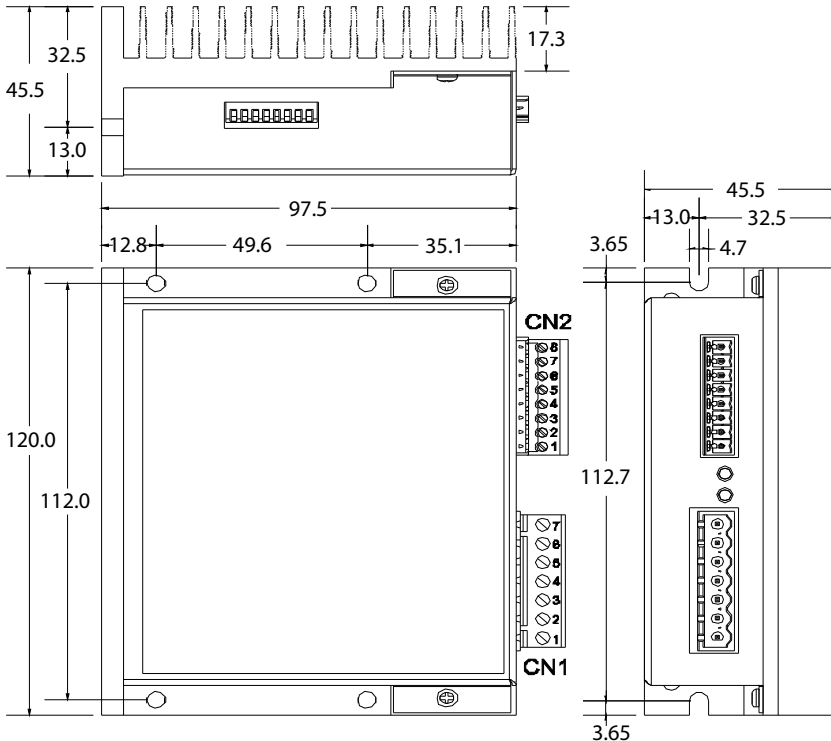

Connections

CN1: Stepper motor 7 position, pitch 5.08 mm, plug connector			
CN1.1	EARTH	POWER_IN	Main Earthing Terminal (Earth Ground)
CN1.2	GND	POWER_IN	Negative Terminal of power supply (-)
CN1.3	V+	POWER_IN	Positive Terminal of power supply (+)
CN1.4	A	POWER_OUT	Motor Output phase A
CN1.5	A/	POWER_OUT	Motor Output phase A/
CN1.6	B	POWER_OUT	Motor Output phase B
CN1.7	B/	POWER_OUT	Motor Output phase B/

CN2: Digital inputs and output 8 position, pitch 3.81 mm, plug connector			
CN2.1	+ EN	DIG_IN	Positive terminal digital input EN (ENABLE)
CN2.2	- EN	DIG_IN	Negative terminal digital input EN (ENABLE)
CN2.3	+ STEP	DIG_IN	Positive terminal digital input STEP (STEP or CLK_UP)
CN2.4	- STEP	DIG_IN	Negative terminal digital input STEP (STEP or CLK_UP)
CN2.5	+ DIR	DIG_IN	Positive terminal digital input DIR (DIRECTION or CLK_DOWN)
CN2.6	- DIR	DIG_IN	Negative terminal digital input DIR (DIRECTION or CLK_DOWN)
CN2.7	FAULT_C	DIG_OUT	FAULT output (Transistor Collector)
CN2.8	FAULT_E	DIG_OUT	FAULT output (Transistor Emitter)

Jumper and Dip-Switches Settings

		off	off	off	off			off	off	off	off	off	off	off	off	Factory Default (**)	
		DIP2 or JMP (internal)							DIP1								
		SW1	SW2	SW3	SW4	SW5	Arms	Apk	SW1	SW2	SW3	SW4	SW5	SW6	SW7	SW8	Step Angle
Rising Edge	off						5.53	7.80	off	off	off		off	off	off	off	Reserved (*)
Falling Edge	on						4.96	7.00	on	off	off		off	on	off	off	Full step
STEP-DIR Mode		off					4.54	6.40	off	on	off		off	off	on	off	1/250
CLK_UP / CLK_DOWN Mode		on					4.04	5.70	on	on	off		off	on	on	off	1/125
EN asserted = Drive Disable			off				3.48	4.90	off	off	on		off	off	off	on	1/50
EN asserted = Drive Enable			on				2.98	4.20	on	off	on		off	on	off	on	1/25
Voltage Mode Disabled				off			2.48	3.50	off	on	on		off	off	on	on	1/10
Voltage Mode Enabled				on			1.99	2.80	on	on	on		off	on	on	on	1/5
High Motor Phase Current Range					off		2.77	3.90	off	off	off		on	off	off	off	1/256
Low Motor Phase Current Range					on		2.48	3.50	on	off	off		on	on	off	off	1/128
							2.27	3.20	off	on	off		on	off	on	off	1/64
JMP1	Function						2.06	2.90	on	on	off		on	on	on	off	1/32
on position	1	Rising Edge					1.77	2.50	off	off	on		on	off	off	on	1/16
on position	2	Falling Edge					1.49	2.10	on	off	on		on	on	off	on	1/8
JMP2	Function						1.28	1.80	off	on	on		on	off	on	on	1/4
on position	3	STEP-DIR Mode					0.99	1.40	on	on	on		on	on	on	on	1/2
on position	4	CLK_UP / CLK_DOWN Mode										off		Idle Current Reduction Enable			
JMP3	Function											on		Idle Current Reduction Disable			
on position	5	EN asserted = Drive Disable															
on position	6	EN asserted = Drive Enable															
on position	7	Voltage Mode Disabled															
on position	8	Voltage Mode Enabled															
on position	9	High Motor Phase Current Range															
on position	10	Low Motor Phase Current Range															

 **NOTE:** the device reads the Dip-Switches and jumpers or DIP2 only during Power up. If it's necessary a settling change, shut down the system, change the settings and start up the system again to make the changes operating.

(*) = DIP1 SW5-6-7-8 = off: forces the system into ESM state (Enable Setup Mode – Factory Reserved). This state is chosen as Default because it prevents any movement of the motor until the user doesn't voluntarily configure the Dip-Switches.

(**) = Dip-Switches configuration "Factory Default"

Connection to the digital inputs

3 24Vdc Line Driver digital inputs which can be used individually with different connections ;
it's not possible use 5Vdc digital inputs ;

 **When a clock is applied to the STEP and/or DIR inputs, the initial frequency has to be lower then 8KHz ($T > 125\mu\text{sec}$). The frequency can be increased further until the maximum value.**

24V INPUTS

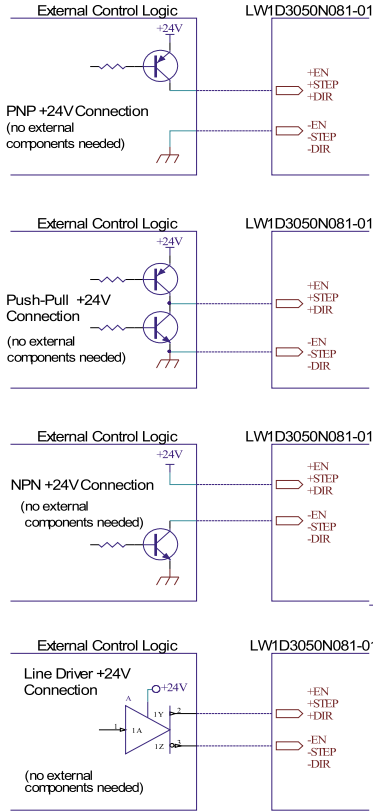

Connection to the digital output

The FAULT output is dimensioned to function at $V_{OUTmax}=24Vdc$, $I_{OUTmax}=100mA$
OK = transistor Output Closed, READY Led ON - FAULT = transistor Output Open, READY Led OFF

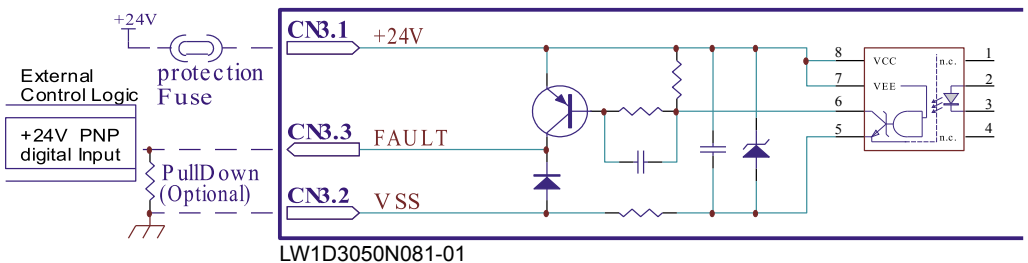

Mating connectors

Connector	Description	Order code
CN1	7 position, pitch 5.08mm., plug connector PHOENIX CONTACT p# MSTB 2,5/7-ST-5,08	1757064
CN2	8 position, pitch 3.81mm., plug connector PHOENIX CONTACT p# MC 1,5/8-ST-3,81	1803633

Cables section

Function	Cable	
	Minimum	Maximum
Power supply	0.5 mm ² (AWG20)	1.5 mm ² (AWG15)
Motor output	0.5 mm ² (AWG20)	1.5 mm ² (AWG15)
Digital inputs	0.14 mm ² (AWG25)	0.5 mm ² (AWG20)
Digital output	0.14 mm ² (AWG25)	0.5 mm ² (AWG20)

Verify the installation

- Check all connections : Power supply, Stepper motor and control logics.
- Make sure that all settings are correct for the application.
- Make sure that the characteristics of the DC power supply are appropriate for the drive.
- If possible, remove the load from the rotor of the motor to avoid wrong movements and eventual damages.
- Supply power and make sure that the green led POWER ON is on. If the led is OFF, shut down immediately and check if all connections are correct.
- Enable the current in the motor (without STEP Clock) and, if possible, verify the presence of the Holding Torque.
- Execute a movement of some steps and verify if the rotation direction is the desired one.



 If the motion direction is not the desired one, it is possible to change it leaving the DIR input unchanged and reversing the connection of a single phase of the motor to CN1, for example A with A/.

- Disconnect the power supply, fix the motor to the load and check the full functionality.

Analysis of malfunctions

The green led POWER ON of the LW1D3050N081-01 indicates that the drive is correctly powered.

When one of the following situations occurs, the drive is put to a state of error, opens the transistor of the FAULT output and switches OFF the green READY Led.

	DEFECT	CAUSE	ACTION
	The external fuse on the power supply of the drive is burned.	Can be caused due to a wrong connection of the power supply.	Connect the power supply correctly and replace the fuse.
	Intervention of the thermal protection.	Can be caused due to a heavy working cycle or a high current in the motor.	Improve the drive cooling by a decent air flow or a fan. Consider to use a motor with a higher torque vs current rating.
	Intervention of the current protection.	Short circuit to the motor output stage(s) of the drive.	Check motor windings and cables and remove the short circuits replacing the faulty cables or the motor if necessary.

When any of the following situations occur, the drive isn't placed in an error condition, the output transistor and the green led FAULT remain closed.

	DEFECT	CAUSE	ACTION
	Noisy motor movement with vibrations.	Can be caused due to a lack of power supply to a phase of the motor, a poor regulation of the winding currents.	Check the cables and connections of the motor. Increase the resolution of the step angle (DIP1 SW5-6-7-8) and/or change the motor speed to exit a resonance region.
	At higher speed the motor hasn't enough torque	Can be caused due to the self-limitation of the motor current.	Enable the VOLTAGE Mode (DIP2 SW4 = On or JMP4 closed in position 8).

EVER Elettronica

Via del Commercio, 2/4 - 9/11

Loc. San Grato Z. I

26900 - L O D I - Italy

Phone +39 0371 412318 - Fax +39 0371 412367

email: infoever@everelettronica.it

web: www.everelettronica.it

